

# SUSHI & SASHIMI



DURE is eco-conscious and advances through top-notch products and services.

**DURE**







# SUSHI & SASHIMI CONTAINER

## INFORMATION

MATERIAL	PAPER/PULP	PP	PET	PLA
MARK				
MICROWAVE	✓	✓	✗	✗

- Due to the nature of the molded product, there may be some errors depending on the measuring position.
- The lid cannot be used when cooking in a direct fire, oven, or microwave. • Unit(inch)







DURE Packaging Container

# SUSHI & SASHIMI CONTAINER

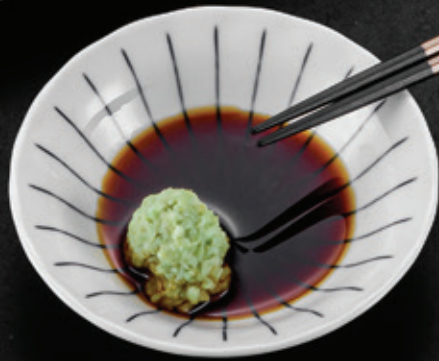

Sushi  
Flat



### DR-SUSHI-100 (6P)

9.4"×4.3"×2"(SET)

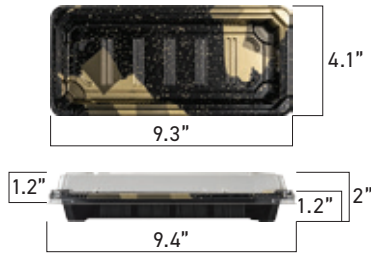

### E-SUSHI-3 (6P)

10.8"×5.3"×1.6"(SET)

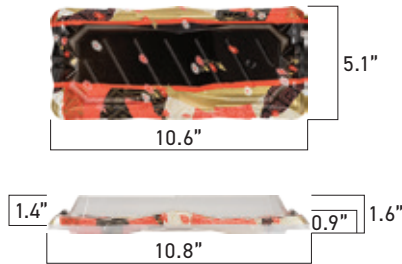

### LM-SUSHI-19 (8P)

8.5"×5.3"×1.9"(SET)

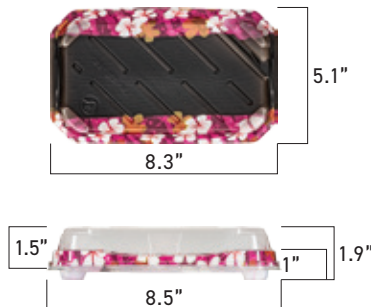

Name	Container	Lid	Compartment	Box Quantity (EA)
DR-SUSHI-100	9.3"×4.1"×1.2" (PLA/PRINT, BLACK)	9.4"×4.3"×1.2" (PLA/CLEAR)	6	400/400
E-SUSHI-3	10.6"×5.1"×0.9" (PLA/PRINT)	10.8"×5.3"×1.4" (PLA/CLEAR)	6	300/300
LM-SUSHI-19	8.3"×5.1"×1" (PLA/PRINT)	8.5"×5.3"×1.5" (PLA/CLEAR)	8	300/300

- Due to the nature of the molded product, there may be some errors depending on the measuring position.
- The lid cannot be used when cooking in a direct fire, oven, or microwave. • Unit(inch)



### DR-SUSHI-200 (8P)

7.2"×5.1"×1.8"(SET)

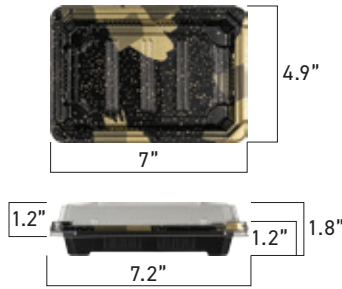

### E-SUSHI-7 (9P)

13.7"×4.4"×2"(SET)

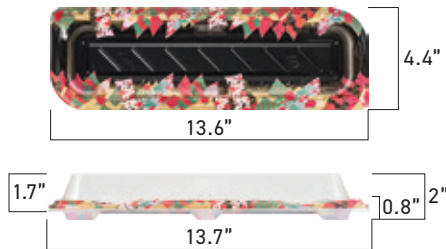

### E-SUSHI-8 (10P)

9.9"×5.9"×2"(SET)



Name	Container	Lid	Compartment	Box Quantity (EA)
DR-SUSHI-200	7"×4.9"×1.2" (PLA/PRINT)	7.2"×5.1"×1.2" (PLA/CLEAR)	8	300/300
E-SUSHI-7	13.6"×4.4"×0.8" (PLA/PRINT)	13.7"×4.4"×1.7" (PLA/CLEAR)	9	200/200
E-SUSHI-8	9.8"×5.8"×0.8" (PLA/PRINT)	9.9"×5.9"×1.7" (PLA/CLEAR)	10	300/300

- Due to the nature of the molded product, there may be some errors depending on the measuring position.
- The lid cannot be used when cooking in a direct fire, oven, or microwave. • Unit(inch)



### LM-SUSHI-7 (10P)

10"×6.5"×2.8"/1.6"(SET)

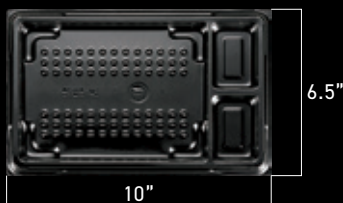

### LM-SUSHI-8 (12P)

12.6"×6.3"×2.8"/1.6"(SET)



### LM-SUSHI-9 (16P)

15.2"×6.3"×2.6"/1.4"(SET)

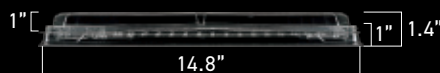
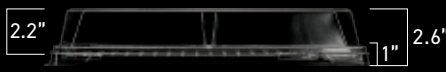

Name	Container	Lid	Compartment	Box Quantity(EA)
LM-SUSHI-7	10"×6.5"×1" (PLA/CLEAR)	9.8"×6.1"×2.2"/1" (PLA/CLEAR)	10	300/300
LM-SUSHI-8	12.6"×6.3"×1" (PLA/CLEAR)	12.6"×6.1"×2.2"/1" (PLA/CLEAR)	12	200/200
LM-SUSHI-9	15.2"×6.3"×1" (PLA/CLEAR)	14.8"×6.1"×2.2"/1" (PLA/CLEAR)	16	200/200

- Due to the nature of the molded product, there may be some errors depending on the measuring position.
- The lid cannot be used when cooking in a direct fire, oven, or microwave. • Unit(inch)



### E-HEART SHAPED SUSHI BOX (10P)

9.8"×8.9"×1.3"(SET)

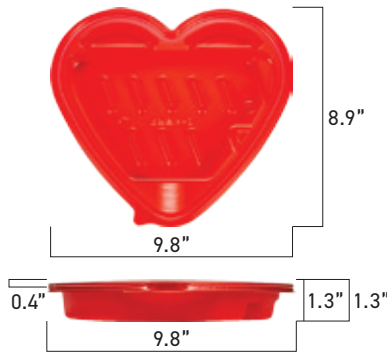

### LM-SUSHI-26 (12P)

10.1"×5.3"×2.1"(SET)



### LM-SUSHI-22 (16P)

13.4"×5.6"×1.9"(SET)



Name	Container	Lid	Compartment	Box Quantity (EA)
E-HEART SHAPED SUSHI BOX	9.8"×8.9"×1.3" (PLA/PRINT)	9.8"×8.9"×0.4" (PLA/CLEAR)	10	200/200
LM-SUSHI-26	10"×5.1"×1" (PLA/PRINT)	10.1"×5.3"×1.7" (PLA/CLEAR)	12	200/200
LM-SUSHI-22	13.2"×5.4"×1" (PLA/PRINT)	13.4"×5.6"×1.5" (PLA/CLEAR)	16	200/200

- Due to the nature of the molded product, there may be some errors depending on the measuring position.
- The lid cannot be used when cooking in a direct fire, oven, or microwave. • Unit(inch)

### DR SUSHI-300 (12P)

9.1"×5.9"×1.8"(SET)

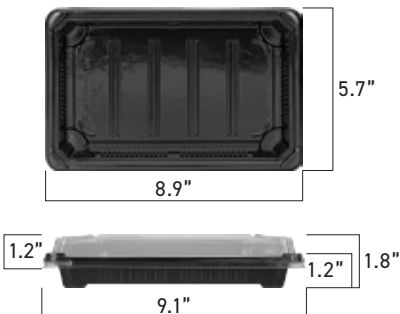
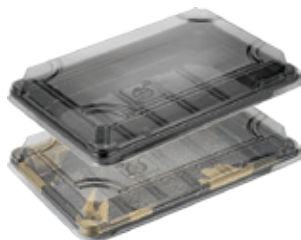

### DR SUSHI-400 (14P)

10"×6.5"×1.9"(SET)

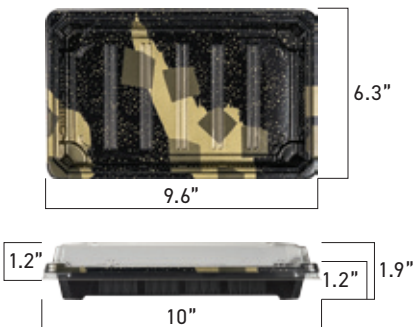

### E-SUSHI-11 (18P)

13.8"×6"×2"(SET)

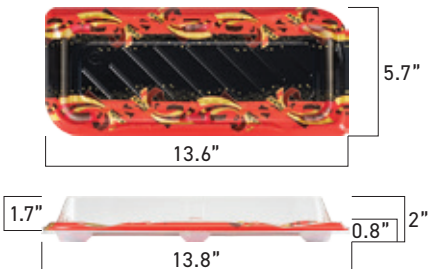

Name	Container	Lid	Compartment	Box Quantity (EA)
DR SUSHI-300	8.9"×5.7"×1.2" (PLA/BLACK,PRINT)	9.1"×5.9"×1.2" (PLA/CLEAR)	12	300/300
DR SUSHI-400	9.6"×6.3"×1.2" (PLA/PRINT)	10"×6.5"×1.2" (PLA/CLEAR)	14	400/400
E-SUSHI-11	13.6"×5.7"×0.8" (PLA/CLEAR)	13.8"×6"×1.7" (PLA/CLEAR)	18	200/200

- Due to the nature of the molded product, there may be some errors depending on the measuring position.
- The lid cannot be used when cooking in a direct fire, oven, or microwave. • Unit(inch)



### LM-SUSHI-24 (20P)

11.3"×8.6"×1.9"(SET)

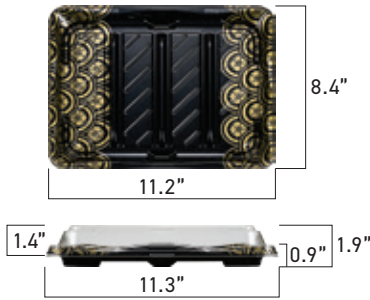

### DRF-900-5 (20P)

11.2"×8.5"×2"(SET)

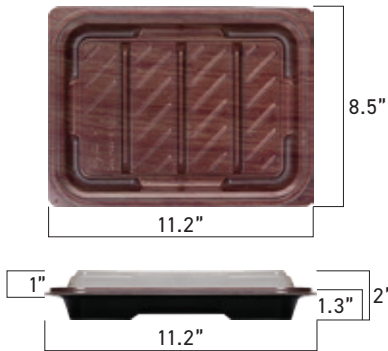

### DR-SUSHI-500 (20P)

10.6"×8.1"×2"(SET)

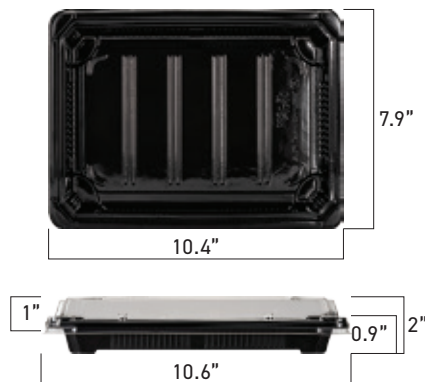
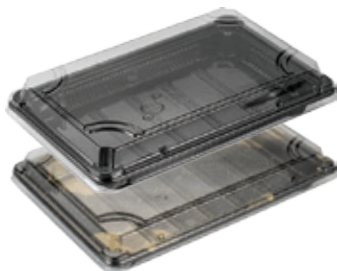

Name	Container	Lid	Compartment	Box Quantity (EA)
LM-SUSHI-24	11.2"×8.4"×0.9" (PLA/PRINT)	11.3"×8.6"×1.4" (PLA/CLEAR)	20	200/200
DRF-900-5	11.2"×8.5"×1.3" (PLA/WOOD)	11.2"×8.5"×1" (PLA/CLEAR)	20	200/200
DR SUSHI-500	10.4"×7.9"×0.9" (PLA/BLACK,PRINT)	10.6"×8.1"×1" (PLA/CLEAR)	20	300/300

- Due to the nature of the molded product, there may be some errors depending on the measuring position.
- The lid cannot be used when cooking in a direct fire, oven, or microwave. • Unit(inch)

**LM-SUSHI-21 (24P)**

13"×8.7"×1.9"(SET)



**LM-SUSHI-31 (28P)**

14"×9.3"×1.9"(SET)

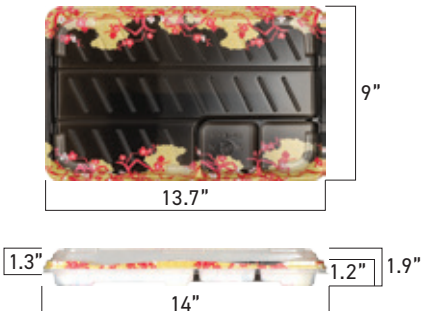

**DRF-1000-3 (32P)**

12.1"×12.1"×2.1"(SET)



Name	Container	Lid	Compartment	Box Quantity (EA)
LM-SUSHI-21	12.8"×8.5"×1" (PLA/PRINT)	13"×8.7"×1.5" (PLA/CLEAR)	24	100/100
LM-SUSHI-31	13.7"×9"×1.2" (PLA/PRINT)	14"×9.3"×1.3" (PLA/CLEAR)	28	100/100
DRF-1000-3	11.8"×11.8"×1.3" (PLA/PRINT)	12.1"×12.1"×1.5" (PLA/CLEAR)	32	70/70

• Due to the nature of the molded product, there may be some errors depending on the measuring position.  
 • The lid cannot be used when cooking in a direct fire, oven, or microwave. • Unit(inch)



**DR-15 (32P)**

19.1"×14"×2.6"(SET)

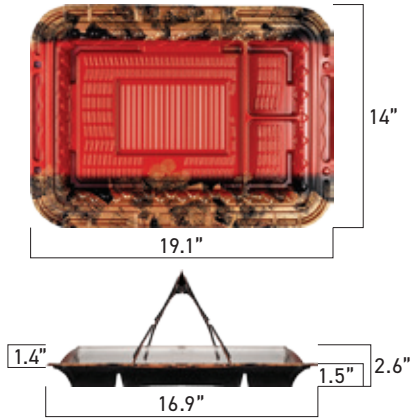

**LM-SUSHI-23 (35P)**

15.2"×14"×1.9"(SET)



**E-SUSHI-14 (36P)**

15.2"×14"×1.9"(SET)

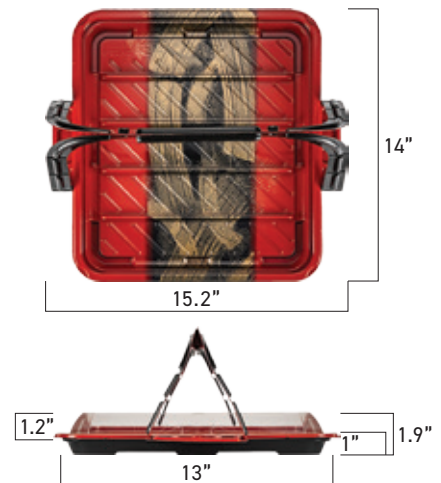

Name	Container	Lid	Compartment	Box Quantity(EA)
DR-15	19.1"×14"×1.5" (PLA/PRINT)	16.9"×11.8"×1.4" (PET/CLEAR)	32	25/25
LM-SUSHI-23	15.2"×14"×1" (PLA/PRINT)	13"×11.8"×1.2" (PLA/CLEAR)	35	50/50
E-SUSHI-14	15.2"×14"×1" (PLA/PRINT)	13"×11.8"×1.2" (PLA/CLEAR)	36	50/50

- Due to the nature of the molded product, there may be some errors depending on the measuring position.
- The lid cannot be used when cooking in a direct fire, oven, or microwave. • Unit(inch)

### DRF-1100-3 (40P)

19.1"×10.2"×2.4"(SET)



### DRE-ROLL (12P)

10.4"×5.3"×2.1"(SET)

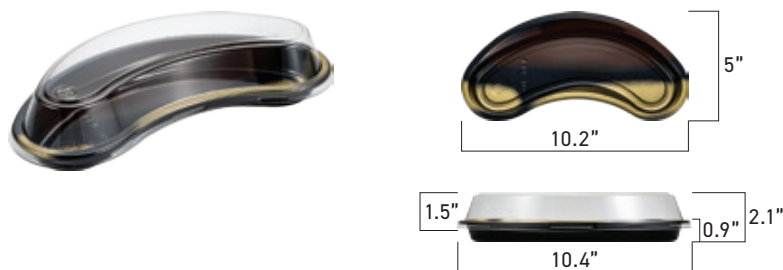

### DRE-HALF ROLL (6P)

6.7"×4.1"×2.1"(SET)

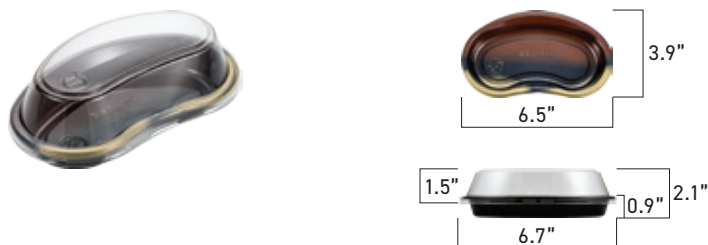

Name	Container	Lid	Compartment	Box Quantity (EA)
DRF-1100-3	18.9"×10"×1.2" (PLA/PRINT)	19.1"×10.2"×1.8" (PLA/CLEAR)	40	100/100
DRE-ROLL	10.2"×5"×0.9" (PLA/PRINT)	10.4"×5.3"×1.5" (PLA/CLEAR)	12	400/400
DRE-HALF ROLL	6.5"×3.9"×0.9" (PLA/PRINT)	6.7"×4.1"×1.5" (PLA/CLEAR)	6	600/600

- Due to the nature of the molded product, there may be some errors depending on the measuring position.
- The lid cannot be used when cooking in a direct fire, oven, or microwave. • Unit(inch)



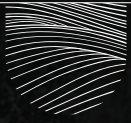

DURE Packaging Container

# SUSHI & SASHIMI CONTAINER



**Sushi**  
Compartment



### DR PACK-37-3 (5P)

Patent No : 30-2022-0003907

12.8"×4.3"×1.7"(SET)

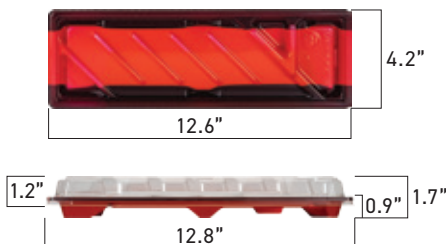

### LM-SUSHI-38 (5P)

10"×4"×1.6"(SET)



### LS-SUSHI-1 (6P)

11.1"×3.9"×1.6"(SET)



Name	Container	Lid	Compartment	Box Quantity (EA)
DR PACK-37-3	12.6"×4.2"×0.9" (PLA/PRINT)	12.8"×4.3"×1.2" (PLA/CLEAR)	5	600/600
LM-SUSHI-38	10"×4"×0.9" (PLA/PRINT)	10"×4"×1.5" (PLA/CLEAR)	5	400/400
LS-SUSHI-1	11.1"×3.9"×0.9" (PLA/PRINT)	11.1"×3.9"×1.5" (PLA/CLEAR)	6	400/400

- Due to the nature of the molded product, there may be some errors depending on the measuring position.
- The lid cannot be used when cooking in a direct fire, oven, or microwave. • Unit(inch)



### LM-SUSHI-33 (8P)

10.1"×7.8"×1.5"(SET)

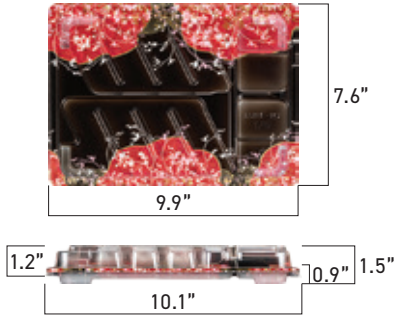

### E-SUSHI-17 (10P)

Patent No : 30-2021-0002827

9.8"×6.2"×1.5"(SET)

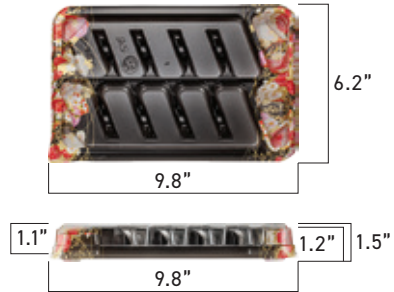

### E-SUSHI-20 (10P)

Patent No : 30-2021-0002827

9.6"×7.5"×1.4"(SET)

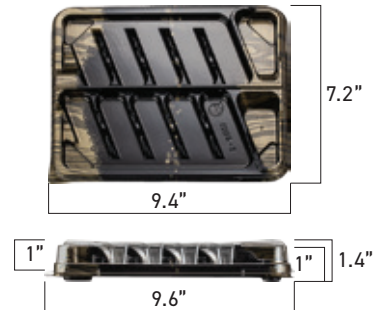

Name	Container	Lid	Compartment	Box Quantity (EA)
LM-SUSHI-33	9.9"×7.6"×0.9" (PLA/PRINT)	10.1"×7.8"×1.2" (PLA/CLEAR)	8	300/300
E-SUSHI-17	9.8"×6.2"×1.2" (PLA/PRINT)	9.8"×6.2"×1.1" (PLA/CLEAR)	10	300/300
E-SUSHI-20	9.4"×7.2"×1" (PLA/PRINT)	9.6"×7.5"×1" (PLA/CLEAR)	10	200/200

- Due to the nature of the molded product, there may be some errors depending on the measuring position.
- The lid cannot be used when cooking in a direct fire, oven, or microwave. • Unit(inch)



### LM-SUSHI-35 (10P)

11.3"×6.7"×1.6"(SET)

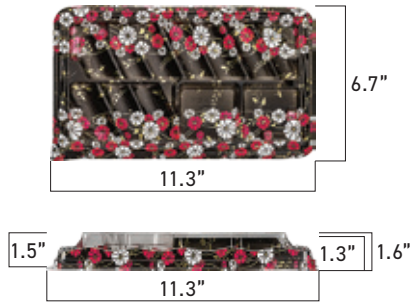

### E-SUSHI-18 (12P)

Patent No : 30-2021-0002830

8.9"×8.8"×1.5"(SET)

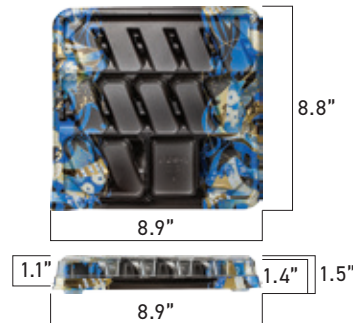

### LM-SUSHI-37 (12P)

13"×7.8"×1.5"(SET)

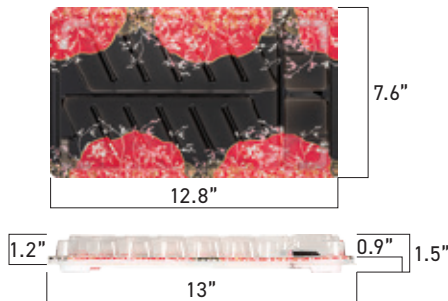

Name	Container	Lid	Compartment	Box Quantity (EA)
LM-SUSHI-35	11.3"×6.7"×1.3" (PLA/PRINT)	11.3"×6.7"×1.5" (PLA/CLEAR)	10	200/200
E-SUSHI-18	8.9"×8.8"×1.4" (PLA/PRINT)	8.9"×8.8"×1.1" (PLA/CLEAR)	12	200/200
LM-SUSHI-37	12.8"×7.6"×0.9" (PLA/PRINT)	13"×7.8"×1.2" (PLA/CLEAR)	12	200/200

- Due to the nature of the molded product, there may be some errors depending on the measuring position.
- The lid cannot be used when cooking in a direct fire, oven, or microwave. • Unit(inch)

### LM-SUSHI-34 (14P)

14.5"×7.8"×1.5"(SET)

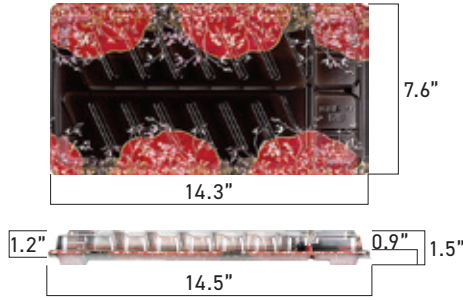
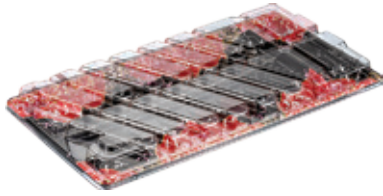

### LM-SUSHI-29 (16P)

Patent No : 20-2021-0002382

13.4"×6.5"×1.9"(SET)

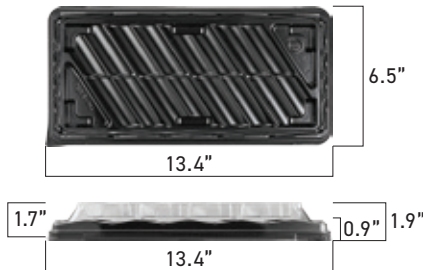

### E-SUSHI-21 (16P)

Patent No : 30-2021-0002827

13.6"×7.5"×1.5"(SET)

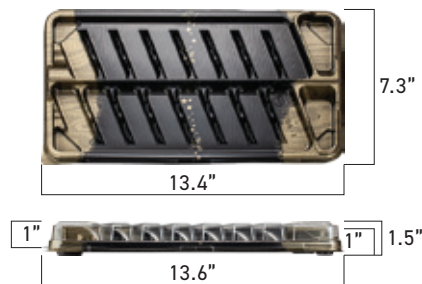

Name	Container	Lid	Compartment	Box Quantity (EA)
LM-SUSHI-34	14.3"×7.6"×0.9" (PLA/PRINT)	14.5"×7.8"×1.2" (PLA/CLEAR)	14	200/200
LM-SUSHI-29	13.4"×6.5"×0.9" (PLA/BLACK)	13.4"×6.5"×1.7" (PLA/CLEAR)	16	200/200
E-SUSHI-21	13.4"×7.3"×1" (PLA/PRINT)	13.6"×7.5"×1" (PLA/CLEAR)	16	200/200

- Due to the nature of the molded product, there may be some errors depending on the measuring position.
- The lid cannot be used when cooking in a direct fire, oven, or microwave. • Unit(inch)

### LM-SUSHI-39 (16P)

15.9"×7.8"×1.5"(SET)

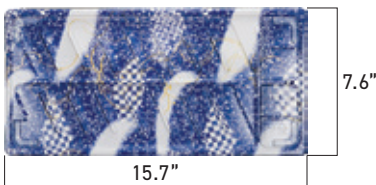

### E-SUSHI-19 (18P)

Patent No : 30-2021-0002833

11.8"×9.1"×1.5"(SET)

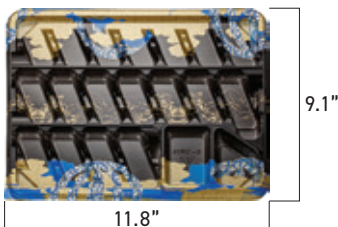
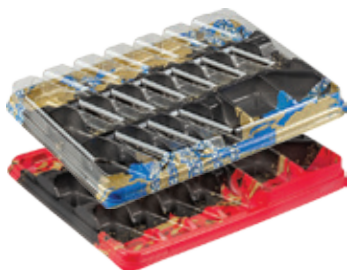

### SH-2 (18P)

Patent No : 30-2021-0026400

11.5"×10.3"×1.6"(SET)

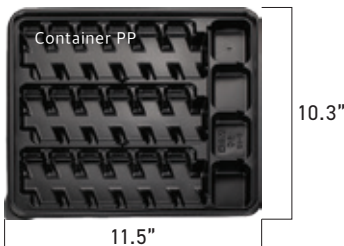
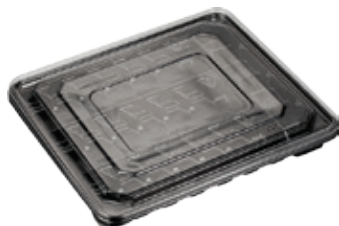

Name	Container	Lid	Compartment	Box Quantity (EA)
LM-SUSHI-39	15.7"×7.6"×0.9" (PLA/PRINT)	15.9"×7.8"×1.2" (PLA/CLEAR)	16	200/200
E-SUSHI-19	11.8"×9.1"×1.4" (PLA/PRINT)	11.8"×9.1"×1.1" (PLA/CLEAR)	18	100/100
SH-2	11.5"×10.3"×1.4" (PP/BLACK)	11.5"×10.3"×0.6" (PET/CLEAR)	18	100/100

- Due to the nature of the molded product, there may be some errors depending on the measuring position.
- The lid cannot be used when cooking in a direct fire, oven, or microwave. • Unit(inch)





### LM-SUSHI-28 (20P)

Patent No : 20-2021-0002382

17.6"×8.9"×1.5"(SET)

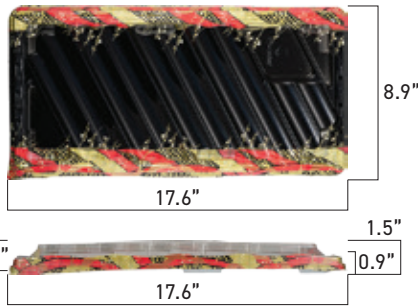
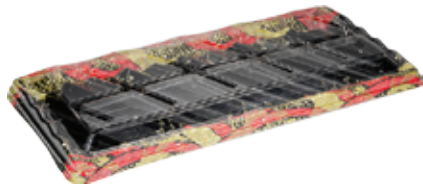

### LM-SUSHI-36 (20P)

12.4"×9.1"×1.6"(SET)

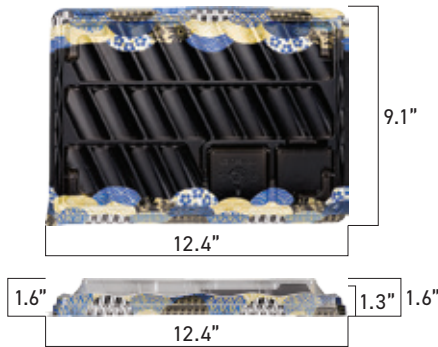
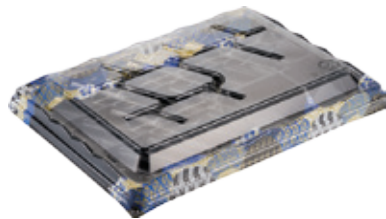

### LM-SUSHI-30 (24P)

Patent No : 20-2021-0002382

14.6"×9.1"×1.6"(SET)

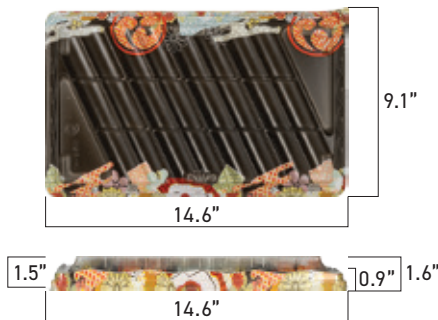

Name	Container	Lid	Compartment	Box Quantity (EA)
LM-SUSHI-28	17.6"×8.9"×0.9" (PLA/PRINT)	17.6"×8.9"×1.3" (PLA/CLEAR)	20	100/100
LM-SUSHI-36	12.4"×9.1"×1.3" (PLA/PRINT)	12.4"×9.1"×1.6" (PLA/CLEAR)	20	100/100
LM-SUSHI-30	14.6"×9.1"×0.9" (PLA/PRINT)	14.6"×9.1"×1.5" (PLA/CLEAR)	24	100/100

- Due to the nature of the molded product, there may be some errors depending on the measuring position.
- The lid cannot be used when cooking in a direct fire, oven, or microwave. • Unit(inch)



**SH-1 (32P)**

Patent No : 30-2021-0026402

14.1"×13.4"×1.6"(SET)

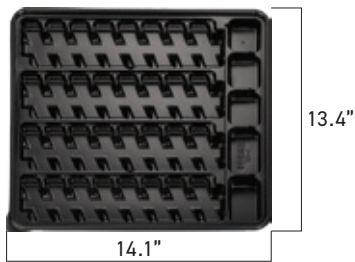
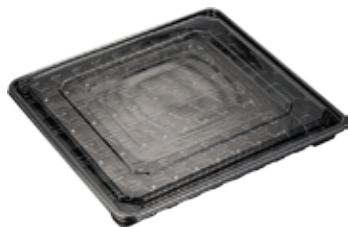

Name	Container	Lid	Compartment	Box Quantity (EA)
SH-1	14.1"×13.4"×1.4" (PP/BLACK)	14.1"×13.4"×0.6" (PET/CLEAR)	32	100/100

- Due to the nature of the molded product, there may be some errors depending on the measuring position.
- The lid cannot be used when cooking in a direct fire, oven, or microwave. • Unit(inch)

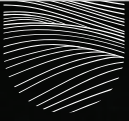

DURE Packaging Container

# SUSHI & SASHIMI CONTAINER



Sashimi



### DR-SASHIMI BOAT-2

15.6"×8.7"×2.2"(SET)

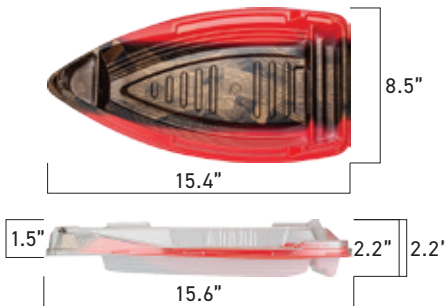
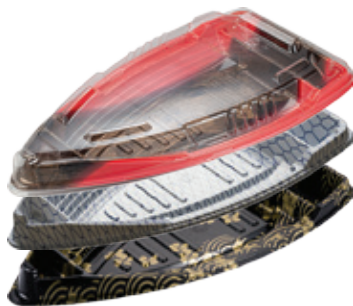

### DR-SASHIMI BOAT-3

20"×8.9"×2.3"(SET)

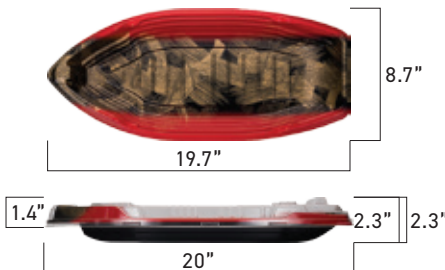
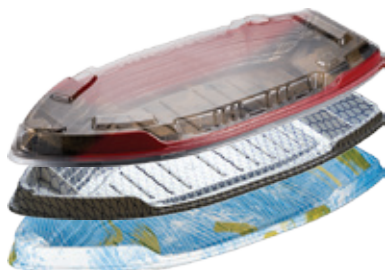

### DR-SASHIMI BOAT-4

Patent No : 30-2022-0031187

13.8"×7.7"×2.4"(SET)

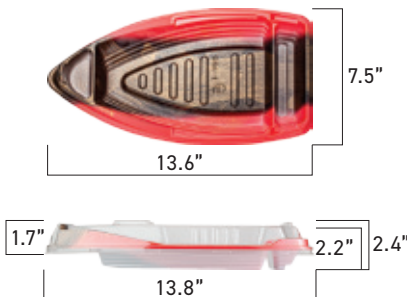

Name	Container	Lid	Shape	Box Quantity (EA)
DR-SASHIMI BOAT-2	15.4"×8.5"×2.2" (PLA/PRINT)	15.6"×8.7"×1.5" (PLA/CLEAR)	Boat	100/100
DR-SASHIMI BOAT-3	19.7"×8.7"×2.3" (PLA/PRINT)	20"×8.9"×1.4" (PLA/CLEAR)	Boat	100/100
DR-SASHIMI BOAT-4	13.6"×7.5"×2.2" (PLA/PRINT)	13.8"×7.7"×1.7" (PLA/CLEAR)	Boat	200/200

- Due to the nature of the molded product, there may be some errors depending on the measuring position.
- The lid cannot be used when cooking in a direct fire, oven, or microwave. • Unit(inch)



### DR-SASHIMI BOAT-2-1

Patent No : 30-2022-0030895

16.6"×8.3"×1.9"(SET)

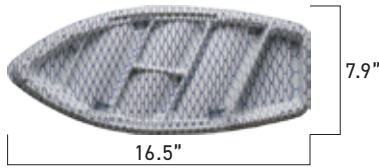

### DR-SASHIMI BOAT-3-2

Patent No : 30-2022-0030895

20"×8.9"×2.1"(SET)



### DR-SASHIMI BOAT-4-1

Patent No : 30-2022-0030895

16.2"×7.1"×1.9"(SET)

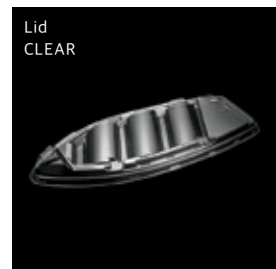

Name	Container	Lid	Shape	Box Quantity (EA)
DR-SASHIMI BOAT-2-1	16.5"×7.9"×1.8" (PLA/PRINT)	16.6"×8.3"×1.4" (PLA/CLEAR)	Boat	100/100
DR-SASHIMI BOAT-3-2	19.7"×8.7"×2.1" (PLA/PRINT)	20"×8.9"×1.4" (PLA/CLEAR)	Boat	100/100
DR-SASHIMI BOAT-4-1	15.9"×6.8"×1.8" (PLA/PRINT)	16.2"×7.1"×1.4" (PLA/CLEAR)	Boat	100/100

- Due to the nature of the molded product, there may be some errors depending on the measuring position.
- The lid cannot be used when cooking in a direct fire, oven, or microwave. • Unit(inch)

### DRE-SASHIMI-16-7

15.9×10.1"×2"(SET)

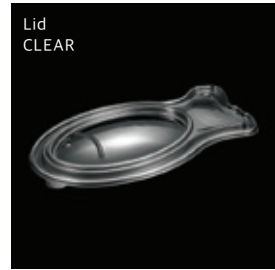
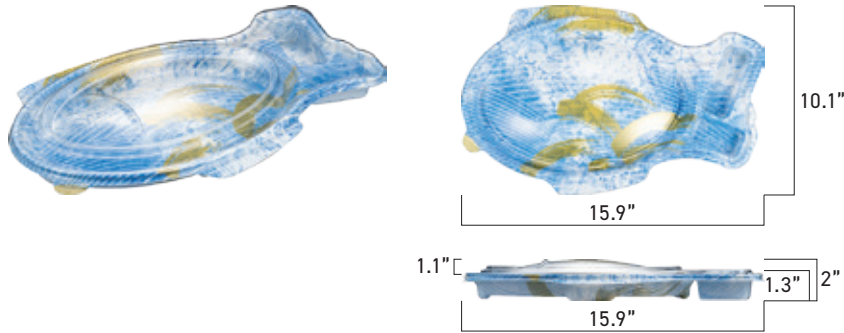

### ECO-200(FLOWER)

14.3×9.5"×2.3"(SET)

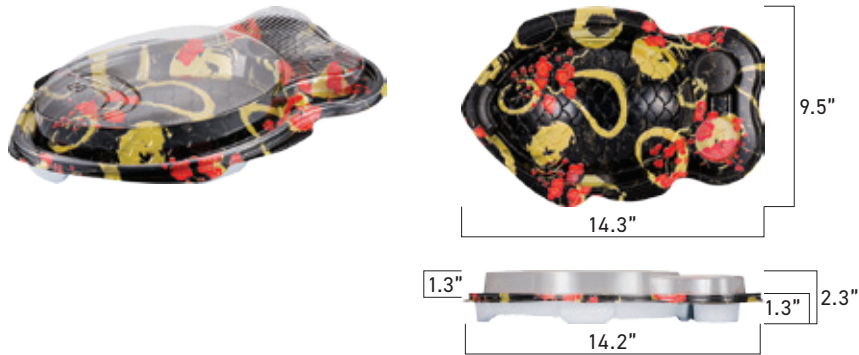

### ECO-200(BLUE)

14.3×9.5"×1.8"(SET)

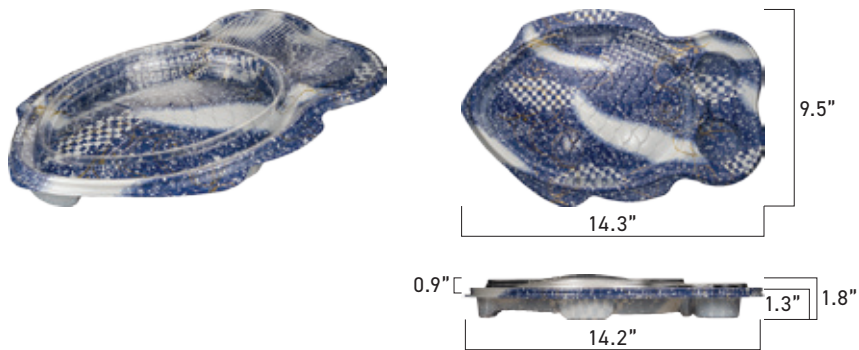

Name	Container	Lid	Shape	Box Quantity (EA)
DRE-SASHIMI-16-7	15.9"×10.1"×1.3" (PLA/PRINT)	15.9"×8.9"×1.1" (PLA/CLEAR)	Fish	100/100
ECO-200(FLOWER)	14.3"×9.5"×1.3" (PLA/PRINT)	14.2"×8.5"×1.3" (PLA/CLEAR)	Fish	100/100
ECO-200(BLUE)	14.3"×9.5"×1.3" (PLA/PRINT)	14.2"×8.5"×0.9" (PLA/CLEAR)	Fish	100/100

- Due to the nature of the molded product, there may be some errors depending on the measuring position.
- The lid cannot be used when cooking in a direct fire, oven, or microwave. • Unit(inch)



### N-SASHIMI-4

7.7"×7.7"×2.4"(SET)

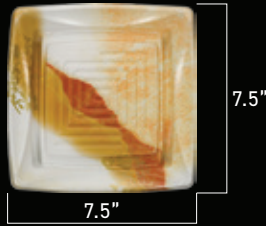

### N-SASHIMI-5

10"×7.7"×2.4"(SET)

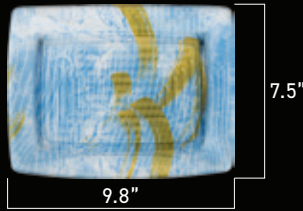
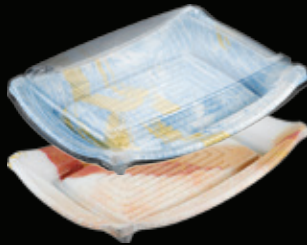

Name	Container	Lid	Shape	Box Quantity (EA)
N-SASHIMI-4	7.5"×7.5"×1.6" (PLA/BLACK,RED)	7.7"×7.7"×1.2" (PLA/CLEAR)	Square	200/200
N-SASHIMI-5	9.8"×7.5"×1.6" (PLA/PRINT)	10"×7.7"×1.6" (PLA/CLEAR)	Square	100/100

- Due to the nature of the molded product, there may be some errors depending on the measuring position.
- The lid cannot be used when cooking in a direct fire, oven, or microwave. • Unit(inch)

**LM-MINI-SASHIMI S**

5.8"×4.6"×2.2"(SET)

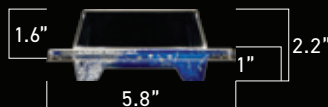
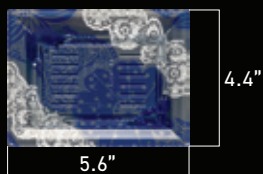
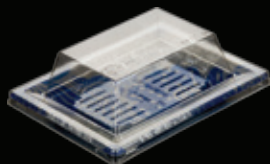
Lid  
CLEAR**LM-MINI-SASHIMI M**

9.9"×4.6"×2.2"(SET)

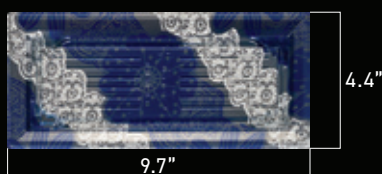
Lid  
CLEAR**LM-MINI-SASHIMI L**

11"×6.9"×2.2"(SET)

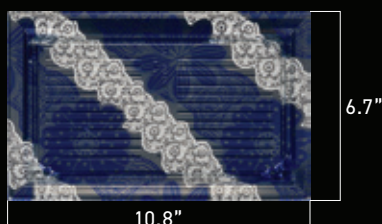
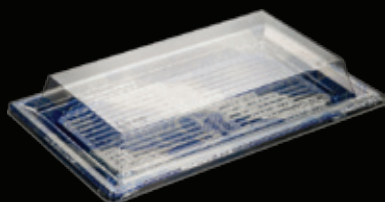
Lid  
CLEAR

Name	Container	Lid	Shape	Box Quantity (EA)
LM-MINI-SASHIMI S	5.6"×4.4"×1" (PLA/PRINT)	5.8"×4.6"×1.6" (PLA/CLEAR)	Square	400/400
LM-MINI-SASHIMI M	9.7"×4.4"×1" (PLA/PRINT)	9.9"×4.6"×1.6" (PLA/CLEAR)	Square	300/300
LM-MINI-SASHIMI L	10.8"×6.7"×1" (PLA/PRINT)	11"×6.9"×1.6" (PLA/CLEAR)	Square	200/200

- Due to the nature of the molded product, there may be some errors depending on the measuring position.
- The lid cannot be used when cooking in a direct fire, oven, or microwave. • Unit(inch)

### LM-SASHIMI 3P

17.5"×4.7"×1.5"(SET)

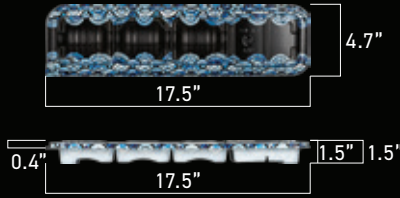
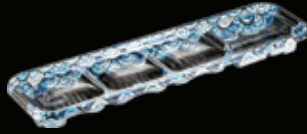

### LM-SASHIMI 4P

13.7"×8.1"×1.5"(SET)

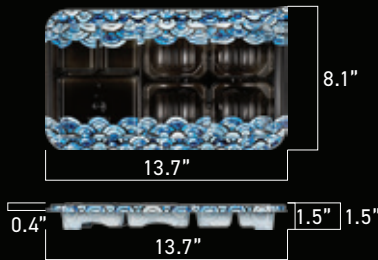
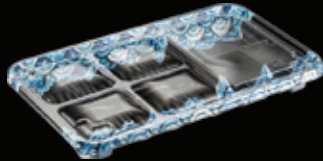

### LM-SASHIMI 6P

17.5"×8.1"×1.5"(SET)

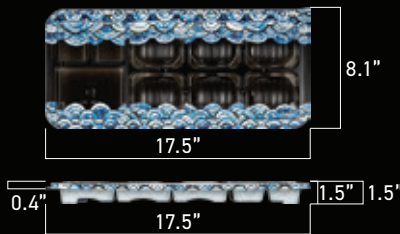
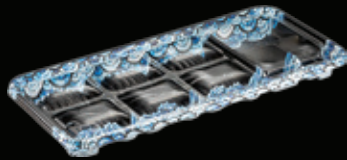

### LM-SASHIMI 8P

21.3"×8.1"×1.5"(SET)

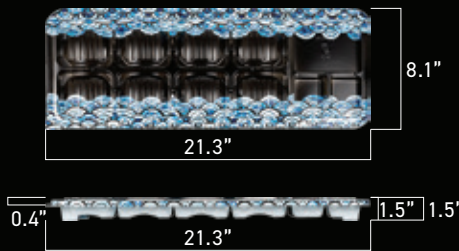
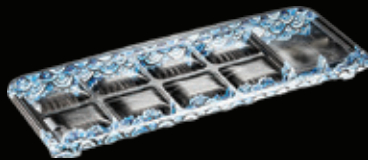

Name	Container	Lid	Shape	Box Quantity (EA)
LM-SASHIMI 3P	17.5"×4.7"×1.5" (PLA/PRINT)	17.5"×4.7"×0.4" (PLA/CLEAR)	Square	200/200
LM-SASHIMI 4P	13.7"×8.1"×1.5" (PLA/PRINT)	9.8"×8.1"×0.4" (PLA/CLEAR)	Square	200/200
LM-SASHIMI 6P	17.5"×8.1"×1.5" (PLA/PRINT)	17.5"×8.1"×0.4" (PLA/CLEAR)	Square	100/100
LM-SASHIMI 8P	21.3"×8.1"×1.5" (PLA/PRINT)	21.3"×8.1"×0.4" (PLA/CLEAR)	Square	100/100

- Due to the nature of the molded product, there may be some errors depending on the measuring position.
- The lid cannot be used when cooking in a direct fire, oven, or microwave. • Unit(inch)



### DRE-SASHIMI-16-6

14.6"×10"×2.2"(SET)

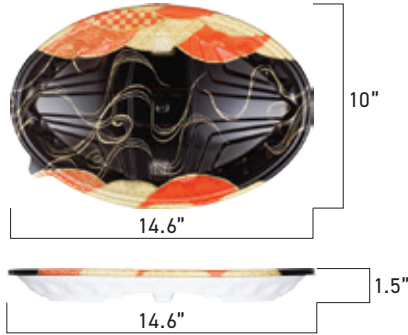
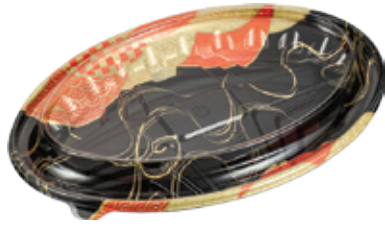

### DRE-SASHIMI-17-2

17.8"×11.7"×2.6"(SET)

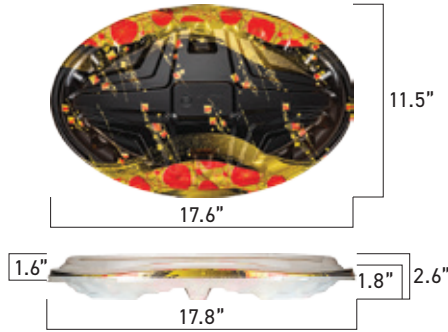

### LM-OVAL SASHIMI M

12.1"×9.3"×2"(SET)

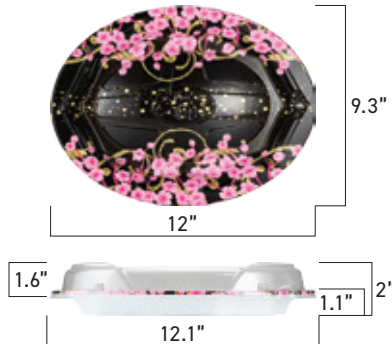

Name	Container	Lid	Shape	Box Quantity (EA)
DRE-SASHIMI-16-6	14.6"×10"×1.5" (PLA/PRINT)	14.6"×10"×1.1" (PLA/CLEAR)	Oval	100/100
DRE-SASHIMI-17-2	17.6"×11.5"×1.8" (PLA/PRINT)	17.8"×11.7"×1.6" (PLA/CLEAR)	Oval	50/50
LM-OVAL SASHIMI M	12"×9.3"×1.1" (PLA/PRINT)	12.1"×9.3"×1.6" (PLA/CLEAR)	Oval	200/200

- Due to the nature of the molded product, there may be some errors depending on the measuring position.
- The lid cannot be used when cooking in a direct fire, oven, or microwave. • Unit(inch)

### LM-OVAL SASHIMI M-1

13.7"×9.4"×2"(SET)

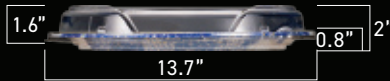
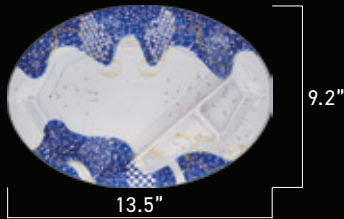

### LM-OVAL SASHIMI M-2

13.7"×9.4"×2.1"(SET)

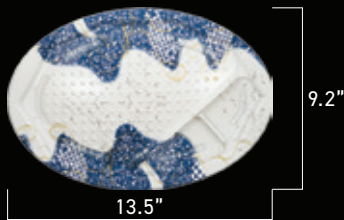

Name	Container	Lid	Shape	Box Quantity (EA)
LM-OVAL SASHIMI M-1	13.5"×9.2"×0.8" (PLA/PRINT)	13.7"×9.4"×1.6" (PLA/CLEAR)	Oval	200/200
LM-OVAL SASHIMI M-2	13.5"×9.2"×1.2" (PLA/PRINT)	13.7"×9.4"×1.8" (PLA/CLEAR)	Oval	200/200

- Due to the nature of the molded product, there may be some errors depending on the measuring position.
- The lid cannot be used when cooking in a direct fire, oven, or microwave. • Unit(inch)

### LM-OVAL SASHIMI L

16.1"×10"×2"(SET)

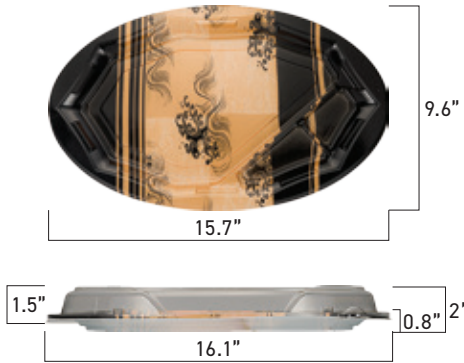

### VIC-OVAL SASHIMI

14.8"×9.8"×2.2"(SET)

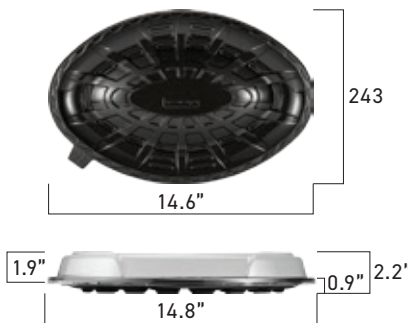

Name	Container	Lid	Shape	Box Quantity (EA)
LM-OVAL SASHIMI L	15.7"×9.6"×0.8" (PLA/BLACK)	16.1"×10"×1.5" (PLA/CLEAR)	Oval	200/200
VIC-OVAL SASHIMI	14.6"×9.6"×0.9" (PLA/BLACK,PRINT)	14.8"×9.8"×1.9" (PLA/CLEAR)	Oval	200/200

- Due to the nature of the molded product, there may be some errors depending on the measuring position.
- The lid cannot be used when cooking in a direct fire, oven, or microwave. • Unit(inch)





**DURE Co., Ltd.**

759-17, Iseopdaecheon-ro, Hobeop-myeon, Icheon-si, Gyeonggi-do, Republic of Korea (17393)  
TEL (+82) 31.638.7976 | FAX (+82) 31.638.7980 | E-mail sales@durepack.com | www.durepack.com  
© Dure. All Rights Reserved.